



REPAIR MANUAL EZM 1000 & EZM 2000



Date : October 2009
Revision : 05

Masterfix Products by
P.O. box 21
6190AA Beek
The Netherlands



© 2008 Masterfix Products bv
All rights reserved.

The information provided may not be reproduced and/or made public in any way and through any means (electronically or mechanically) without prior explicit and written permission from Masterfix Products bv.

The information provided is based on the data known at the moment of the introduction of this product. Masterfix Products bv pursues a policy of continuous product improvement and therefore the products may be subject to change.

The information provided is applicable to the product as delivered by Masterfix Products bv. Therefore, Masterfix Products bv cannot be held liable for any damage resulting from deviations from the original specifications of the product.

The information available has been composed with the utmost care. However, Masterfix Products bv will not accept any liability with respect to any faults in the information nor for the consequences thereof. Masterfix Products bv will not accept any liability for damage resulting from activities carried out by third parties.

The working names, trade names, registered trade marks, etc. used by Masterfix Products bv should not be considered as being free, pursuant to the legislation with respect to the protection of trade marks.

1	INTRODUCTION.....	6
2	USED SYMBOLS.....	6
3	SAFETY INSTRUCTIONS.....	6
3.1.1	Discharge of the oil according legislation.....	7
3.1.2	Service and maintenance.....	7
3.1.3	Guarantee conditions.....	7
4	NECESSARY SERVICE TOOLS.....	7
5	DISASSEMBLING.....	10
5.1	Frequent maintenance.....	10
5.1.1	Disassembling the front sleeve (X11).....	10
5.1.2	Disassembling the clamping sleeve (X06 or X07) and jaws (X05).....	11
	Step 1: unscrew/unlock the clamping sleeve.....	11
	Step 2: take out the several components.....	11
5.1.3	Disassembling the conduit (X09 or X10).....	11
5.2	Disassembling up to hydraulic part.....	12
5.2.1	Disassembling the retraction system (X17).....	12
	Step 1: unscrew the two hexagonal cap screws.....	12
	Step 2: take out the several internal components of the retraction system.....	12
	Step 3: pull out the T-part piston (X18).....	13
	Step 4: unscrew the nut of body.....	13
5.2.2	Disassembling the pneumatic cylinder (X32 or X33).....	14
	Step 1: unscrew with special tool.....	14
	Step 2: unscrew by hand.....	14
5.2.3	Disassembling the pneumatic plunger (X27 or X28).....	14
5.2.4	Disassembling the air connector tube including the pressure relief valve (X37 or X38).....	15
	Step 1: disassemble the pre-assembled hose.....	15
	Step 2: pull of the pre-assembled hose.....	15
	Step 3: Unscrew the pre-assembled pressure relief valve.....	15
5.2.5	Disassembling the complete assembled trigger (X39).....	16
	Step 1: Disassemble the trigger.....	16
	Step 2: Disassemble the trigger valve.....	16
	Step 3: Disassemble the trigger pin.....	16
5.2.6	Disassembling the complete air supply ring parts.....	17
	Step 1: unscrewing the assembly nut (X45).....	17
	Step 2: unscrew the hexagonal screws.....	17
	Step 3: take of body bottom part (X42/43 or X44) and the air supply ring (X22 or X23) ..	17
	Step 4: disassemble the air supply ring and parts.....	18
5.2.7	Disassembling the main valve (X21).....	18
	Step 1: disassemble the valve bottom.....	18
	Step 2: take out the nylon ball.....	19
	Step 3: dismantle the valve house and valve.....	19
	Step 4: push out the valve.....	19
5.3	Disassembling hydraulic parts.....	19
5.3.1	Drain away the oil.....	19
	Step 1: unscrew the oil fill screw.....	19
	Step 2: Drain away the oil.....	20
	Step 3: pull out the pneumatic plunger.....	20
5.3.2	Push out the hydraulic plunger (X16).....	21
5.3.3	Dismount the seals (X14).....	21
5.3.4	Disassembling the insertion (X20).....	22
5.3.5	Dismount the seals of the insertion (X24).....	22
6	ASSEMBLING.....	23
6.1	Assembling seals hydraulic body (X14).....	23
	Step 1: Placing the guiding band (1).....	23
	Step 2: Placing the X-ring (2).....	24
	Step 3: Placing the stepseal including the O'ring (3).....	24
1.1	Assembling seals hydraulic Piston (X16).....	24
	Step 1: Placing the X-ring.....	25
	Step 2: Placing the O-ring and the stepseal.....	25

	Step 3: Placing Teflon PTFE FOA 32	25
	Step 4: Placing the inner O - ring 12/2,5 VITON.....	26
6.2	Assembling the hydraulic piston (X15) in the Hydraulic Body (X12 OR X13).....	26
	Step 1: preparing assembling hydraulic piston (X15) in hydraulic body (X12 or X13).....	26
	Step 2: greasing the assembling parts.....	26
	Step 3: assembling the hydraulic piston (X15) in the body (X12 or X13)	27
6.3	Assembling the main valve (X21)	27
	Step 1: Grease the valve.....	28
	Step 3: placing the valve and valve house.....	28
	Step 4: placing the bottom valve	28
6.4	Assembling seal set insertion hydraulic body (X24)	29
	Step 1: place outer O'ring	29
	Step 2: placing the guiding band.....	29
	Step 3: Placing the inner O'ring	30
	Step 4: placing the Glyd Ring + O - ring	30
	Step 5: place the O-Ring 15/1,5 Sh 90	30
6.5	Assembling insertion (X20)	31
	Step 1: grease the inside of the body	31
	Step 2: assemble the insertion in the body	31
	Step 3: tighten the insertion	31
6.6	Assembling complete retraction system (X17).....	31
	Step 1: preparing nut of body.....	31
	Step 2: screwing the nut in the body.....	32
	Step 3: preparing and assembling the T-part piston (X18)	32
	Step 4: completing the retraction system.....	33
	Step 5: screwing on the hood.....	34
6.7	Assembling the air supply ring (X22) or (X23)	34
6.7.1	Air supply ring EZM1000 (X22).....	34
	Step 1: assembling the air supply ring (X22) on the body bottom part 1 (X42)	35
	Step 2: place the O'ring.....	35
	Step 3: assembling the pneumatic tube (X34)	35
	Step 4: place the assembled air supply ring on the body	36
	Step 5: fixation of the air supply ring.....	37
6.7.2	Air supply ring EZM2000 (X23).....	37
	Step 1: assembling the air supply ring (X23) on the body bottom (X44)	37
	Step 2: place the O-ring	38
	Step 3: assembling the pneumatic tube (X35)	38
	Step 4: place the assembled air supply ring on the body	39
	Step 5: fixation of the air supply ring.....	39
6.7.3	Assemble the assembly nut for both versions (X45)	40
6.8	Assembling complete trigger (X39).....	40
	Step 1: Grease the parts	40
	Step 2: screw on the pre-assembled valve (1).....	41
	Step 3: place the trigger piston	41
	Step 4: place the trigger	41
6.9	Assembling the air connector tube including the pressure relief valve (X37) or (X38)	42
	Step 1: assembling the pre assembled pressure relief valve on the air supply ring.....	42
	Step 3: greasing the parts	42
	Step 4: assembling the pre assembled hose (1).....	43
	Step 5: place the protective ring (2)	43
6.10	Assembling the scraper ring and nut (X08).....	43
	Step 1: placing the nut	43
	Step 2: place the scraper ring	43
6.11	Assembling the conduit,	43
	Step 1: Greasing the conduit.....	43
	Step 2: placing the conduit in the tool	44
6.12	Place jaw pusher / clamping sleeve (X06 or x07) & the jaws (X05)	44
	Step 1: placing of the jaws	44
	Step 2: lubricate the inside of the clamping sleeve and the jaws	44
	Step 3: place the Jaw Pusher	44

	Step 4: screw on the clamping sleeve on the hydraulic piston	44
6.13	Before the hydraulic oil is filled, test if the tool is assembled well.....	45
	Step 1: connect the tool to the air supply.....	45
	Step 2: test procedure.....	45
	Step 3: Shut off and disconnect the tool	46
6.14	Filling the tool with oil.....	46
6.15	Assembling the pneumatic plunger (part 1) (X25 or X26).....	46
	Step 1: assembling the pneumatic plunger (part 1)	47
	Step 2: place the special tool RT0022 or RT0026 for filling the tool with oil correctly	47
	Step 3: place the oil filling syringes.....	48
	Step 4: complete the oil filling and releasing the air bubbles.....	48
	Step 5: connect the tool to the air supply.....	48
	Step 6: shut off from the air supply	48
	Step 7: Repeat step 4 to 6	48
	Step 8: unscrew the special tools.....	49
	Step 9: place the cap screw with O-ring (X31).....	49
6.16	Assembling the pneumatic plunger (part 2) (X27 or X28).....	49
	Step 1: assemble the inner Seal 14	49
	Step 2: assembling seal 70x60x4,5 (EZM1000) or 90x80x4,25 (EZM2000) (2).....	50
	Step 3: grease the pneumatic plunger (part 1)	50
	Step 4: assemble the pre-assembled pneumatic plunger (part 2) (X27 or X28)	50
6.17	Assembling the pneumatic cylinder (X32 or X33).....	51
	Step 1: greasing the inside of the pneumatic cylinder	51
	Step 2: assemble the pneumatic cylinder (X32 or X33) on the tool.....	51
6.18	Fixation of the clamping sleeve (X06 or X07)	52
	Step 1: connect tool to air supply	52
	Step 2: adjust the clamping sleeve	52
	Step 3: tighten the clamping sleeve	52
	Step 4: disconnect the tool from the air supply	52
6.19	Assembling the front sleeve (X11).....	52
	Step 1: place the O-ring (2) (X11a).....	53
	Step 2: screw the front sleeve on the tool.....	53
	Step 3: test the adjustment of the clamping sleeve	53
6.20	Placing the balancer (X40).....	53
6.21	Placing the pneumatic cylinder cover (X46 or X47)	53
	Step 1: add the glue	53
	Step 2: push the pneumatic cylinder cover over the cylinder	54
7	TECHNICAL DATA	54
8	TROUBLESHOOTING	55
	Place for notes:	56
	Appendix A: cross section EZM1000	57
	Appendix B: cross section EZM2000	59

1 INTRODUCTION

The repair of the EZM1000 & EZM2000 you need special tools, these can be ordered by your subcontractor. Repairing the tool without using special tools can damage the tool.

For any questions, please contact your subcontractor or send the tool for repair to your subcontractor.

Read before you servicing or repair the tool the manual and the repair manual. Pay extra attention to the safety instructions

Your subcontractor shall not be liable under any circumstances for damage or costs occurring due to inexpert use of the tool and/or inexpert repair or replacement of parts.

This manual is based on assembled spare parts, which can be ordered by your subcontractor. The assembling of the pre-assembled parts are not mentioned in this repair manual.

2 USED SYMBOLS

Always read first the text mentioned by the symbols.



Warning



Important message

3 SAFETY INSTRUCTIONS

Following safety rules must be followed for adequate protection or injuries

- The riveting tool should be used exclusively to set blind rivets
- Do not use the tool as a hammer
- When not in use disconnect the tool from the air supply, except when mentioned in the repair manual
- When working with the tool, always carry protection glasses, personal protection like clothes, gloves, ear protection etc.
- Mandrel collector must be mounted on the tool
- When deposition the tool, make sure that it cannot fall down
- Repair work must be done be carried out by skilled personal. In case of doubt, always send back the tool to the manufacturer / subcontractor
- Do not use the tool outside of riveting holes. The blind rivet could be ejected from the tool.
- Always work in clean working conditions
- Always use a correct clamping device, preventing to damage your tool
- Keep the Exploded Drawing with the item numbers and the Parts List in easy reach.
- Never turn the tool towards yourself or towards another person
- Always read each chapter completely before accomplish any work



Before connecting the tool to the air supply, please check the tool for any damages. Be sure that it is safe to connect to the air supply.

3.1.1 Discharge of the oil according legislation.



Discarded tools and oil are to be disposed of in accordance with the local regulations

3.1.2 Service and maintenance.





Masterfix Products bv does not accept any liability for damage that results from non-observance of the mentioned safety instructions (EEC directive 85/374).













3.1.3 Guarantee conditions.





See the Masterfix Products bv guarantee conditions

4 NECESSARY SERVICE TOOLS

Repair tools necessary to service/repair the tool and can be ordered by your subcontractor (Art. Code)

Art. code	Description	picture
RT0008	Conical adapter for assembling seals hydraulic piston	
RT0011	Screw thread cover hydraulic piston for protection seals	
RT0012	Key for lock nut	
RT0017	Special key for alu back plate (nut of body)	
RT0020	Key for trigger valve	

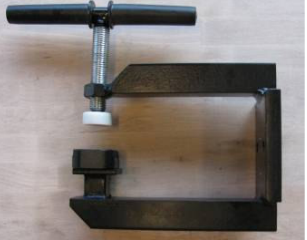
<p>RT0022</p>	<p>Pneumatic piston position/refill oil part for EZM1000</p>	
<p>RT0026</p>	<p>Pneumatic piston position/refill oil part for EZM2000</p>	
<p>RT0029</p>	<p>Oil filling syringes</p>	
<p>RT0033</p>	<p>Distance rod for assembling the stepseal (short version)</p>	
<p>RT0034</p>	<p>Distance rod for assembling the X-ring (middle version)</p>	
<p>RT0035</p>	<p>Distance rod for assembling the guiding ring (long version)</p>	
<p>RT0036</p>	<p>Distance rod for assembling the guiding ring (long version)</p>	
<p>RT0037</p>	<p>Distance rod for assembling the O'ring (middle version)</p>	
<p>RT0038</p>	<p>Distance rod for assembling the glydring (short version)</p>	
<p>RT0039</p>	<p>Clamping tool for hydraulic rod</p>	
<p>RT0041</p>	<p>Pin for centering, assembling and disassembling the conduit</p>	
<p>RT0044</p>	<p>"Dowel" Pin for assembling disassembling pressure relief valve</p>	

<p>RT0046</p>	<p>Precision hook bend (several types)</p>	
<p>RT0047</p>	<p>Strap wrench for dismantle and assembling the pneumatic cylinder <i>(Standard would be delivered the strap with black belt, shown strap wrench below picture can also be used)</i></p>	 <p style="text-align: center;">OR</p> 
<p>RT0048</p>	<p>Tool support <i>(clamp the tool support)</i></p>	
<p>RT0049</p>	<p>Hydraulic oil</p>	
<p>RT0050</p>	<p>Grease</p>	

- Standard tools needed not supplied by your subcontractor:
 - Wrench 15
 - Wrench 17
 - Wrench 19
 - Wrench 23
 - Painting brush for greasing the parts
 - Hexagonal keys for M4, M5, M8
 - Combination grip
 - Small flat Screw driver
 - Tweezers
 - Pattex PL600 / Powerfix "RT0053" (similar glue can be used)
 - Vernier calliper gauge

5 DISASSEMBLING

Disassembling the tool can be done in various ways depending on the level of maintenance or service/repair.

The Disassembling chapter is divided into 3 main chapters:

1. frequent maintenance
2. disassembling up to hydraulic part
3. disassembling hydraulic part



important notes

- **Before servicing or repairing the tool, investigate the tool and see what must be disassembled. Do not disassemble the tool too much.**
- **Before disassembling the tool, first DISCONNECT THE AIR SUPPLY**
- **For servicing/maintenance, always clamp the tool in the tool support RT0048**
- **Dismantling internal seals (placed in grooves) can be disassembled by using a sharp tool such as special tools RT0046. Be careful not to damage the surfaces where the seals are mounted!**
- **Always work in a clean environment**

5.1 Frequent maintenance

Frequent maintenance must be done such as cleaning several parts of the tool

Always disassemble the collector (X19) before starting service/maintenance



Always mount the collector on the tool when the air-supply is connected

5.1.1 Disassembling the front sleeve (X11)

Unscrew the front sleeve (X11) with a wrench 23 and unscrew it further by hand.



Be careful not to damage the trigger

5.1.2 Disassembling the clamping sleeve (X06 or X07) and jaws (X05)

Step 1: unscrew/unlock the clamping sleeve

Disassemble the clamping sleeve (X06 or X07) with a wrench 15 for the clamping sleeve (X06 or X07) and a wrench 17 for the nut (X08). Unscrew the clamping sleeve further with hand

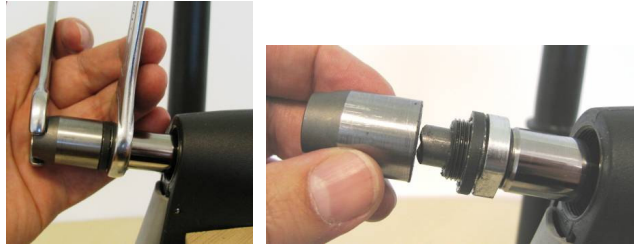

Be careful not to damage the hydraulic piston

Step 2: take out the several components

- Take out the jaws (X05)



- Take of the scraper ring (part of X08) and the jaw pusher (part of X06 or X07)

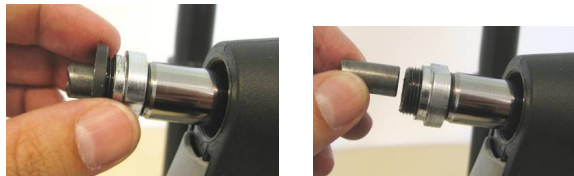

Scraper ring

jaw pusher

- Unscrew the Nut (X08) by hand



5.1.3 Disassembling the conduit (X09 or X10)

X09 for EZM1000

X10 for EZM2000

Push out the conduit from the back of the tool with the special tool **RT0041**. Push until the front of the Conduit is visible at the front of the tool and take it out by hand



Careful place the special tool RT0041 in the back of the tool.

5.2 Disassembling up to hydraulic part

Maintenance, service/repair can be done up to a certain level without releasing the hydraulic oil.

5.2.1 Disassembling the retraction system (X17)

Clamp the tool in the tool support RT0048 vertical.

Step 1: unscrew the two hexagonal cap screws

Unscrew the two hexagonal cap screws with a hexagonal key.

Hold down the aluminum plate by your fingers and pressed it towards the black plastic rotation ring.



When the screws are unscrewed, cover the aluminum plate with your hand. At this way the internal steel balls cannot jump away



Step 2: take out the several internal components of the retraction system

- Take of the aluminum plate



- Take out the spring with little ball (if the ball was not jump out in your hand)



- Take out the small pin including the spring



- Take out the larger steel ball



- Pull of the black plastic rotation wheel

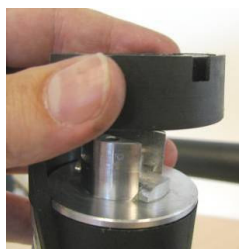

Step 3: pull out the T-part piston (X18)

Pull out the T-part piston (X18) by hand. For lifting up a sharp tool can be used.



Lift up with a sharp tool



pull out with your hand

Step 4: unscrew the nut of body

To unscrew the nut of body use the special tool **RT0017**.



5.2.2 Disassembling the pneumatic cylinder (X32 or X33)

X32 for EZM1000

X33 for EZM2000

Step 1: unscrew with special tool

To unscrew the pneumatic cylinder you can leave on the protection rubber (X46 or X47). To unscrew the pneumatic cylinder use the special tool **RT0047** or similar.

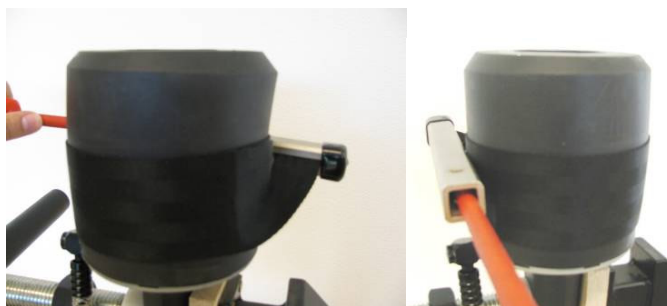

Clamp the tool firmly, it could be that you need lot of force for unscrewing.

Step 2: unscrew by hand

Once the pneumatic cylinder is loose, you can unscrew it by hand



5.2.3 Disassembling the pneumatic plunger (X27 or X28)

X27 for EZM1000

X28 for EZM2000

Just pull of the pneumatic plunger by hand



Additional you can disassemble the pneumatic seal (X29 or X30) by pulling of by hand
 X29 for EZM1000
 X30 for EZM2000



5.2.4 Disassembling the air connector tube including the pressure relief valve (X37 or X38)

X37 for EZM1000
 X38 for EZM2000

Step 1: disassemble the pre-assembled hose

Disassemble the protective ring by pulling of; a small screwdriver or a retaining ring pincer can do this.



Be careful not to injure your hands by slipping of the used tool



Step 2: pull of the pre-assembled hose

Pull off the pre-assembled hose by hand



Step 3: Unscrew the pre-assembled pressure relief valve

Unscrew the pre-assembled pressure relief valve with the special tool **RT0044** by placing this tool in the radial hole and turn it off.



5.2.5 Disassembling the complete assembled trigger (X39)

To disassembling the complete trigger (X39) follow the following steps.

Step 1: Disassemble the trigger

Disassemble the trigger by pushing out the dowel pin with the special tool **RT0044**. Push the dowel pin complete out by this special tool and pull it out by hand.



Push out with special tool



pull out by hand

Step 2: Disassemble the trigger valve

To disassemble the trigger valve use the special tool **RT0020**. Place this tool with the two pins inside the holes of the valve and turn it off.



Place special tool in the holes



unscrew the valve with this tool

Take out the trigger valve by hand



Step 3: Disassemble the trigger pin

Push out the trigger pin with special tool **RT0044** by pushing it from the back to the front. If possible, take it out by hand.



Be careful not to damage the seals inside.

5.2.6 Disassembling the complete air supply ring parts

For the EZM1000 & EZM2000 there are different parts. In the assembling instruction, both versions were explained but for the disassembling instruction, only the EZM2000 was explained. Both versions are more or less similar.

Step 1: unscrewing the assembly nut (X45)

Unscrewing the assembly nut must be done with the special tool **RT0012**. Place this tool over the pneumatic plunger (X25 or X26).



Place special tool



unscrew



take of the nut

Step 2: unscrew the hexagonal screws

Unscrew the hexagonal screw with the a hexagonal key



Unscrew



take out the screws

Step 3: take of body bottom part (X42/43 or X44) and the air supply ring (X22 or X23)

Once the hexagonal screws are taken away, the body bottom part and air supply ring can be pulled from the tool as a complete part including the pneumatic tube (X34 or X35).



Step 4: disassemble the air supply ring and parts

- Take of the air supply ring (X23)



Pre-assembled parts



take of the air supply ring

- Push out the pneumatic tube (X34 or X35)

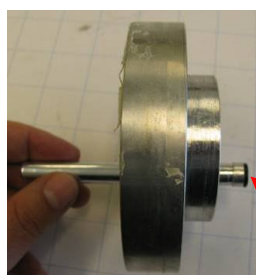

Notice both O-ring



Notice the O-ring; take it out before it will be lose



5.2.7 Disassembling the main valve (X21)

Disassembling the main valve can be done by the special tool **RT0046** or similar.



If the main valve does not have to be disassembling, do not do it.

Step 1: disassemble the valve bottom

Remove the valve bottom by using the special tool **RT0046**, place it under need the valve bottom part, and pull it out.



Place special tool under need the part



take out the bottom valve part

Step 2: take out the nylon ball

Take out the nylon ball by turning the tool upside down the tool.



Step 3: dismantle the valve house and valve

Disassembling can be done by using tweezers.

- Grip the tweezers by one of the vertical protrusion of the valve house and pull it out.

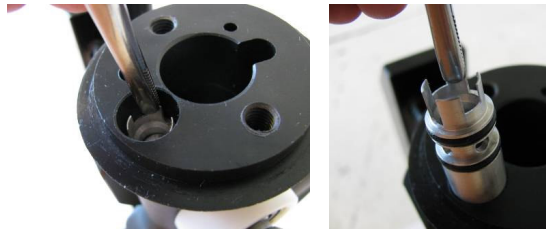

Be careful not to bend the vertical protrusion of the valve

Step 4: push out the valve

Push out the valve out the valve house.



5.3 Disassembling hydraulic parts

When service/maintenance is necessary at hydraulic parts, follow the following steps.

5.3.1 Drain away the oil



Before proceed it is recommended to use eye protection

Step 1: unscrew the oil fill screw

- Place the special tool **RT0039** over the pneumatic plunger (X25 or X26) and clamp it firmly with a combination grip. Use a hexagonal key to unscrew the internal screw inside the pneumatic plunger.



Clamp firmly and unscrew



take out the hexagonal screw

- Check if the O-ring has come with the screw otherwise take it out with a special tool **RT0046**

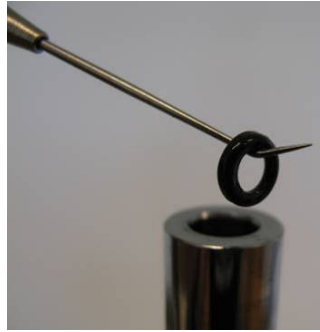

Step 2: Drain away the oil

Drain away the oil legally and use a container or similar. Do this by holding the tool up side down and let flow away the oil.



Step 3: pull out the pneumatic plunger

Pull out the pneumatic plunger by hand. Hold the tool up side down until the most of oil as flow out the tool.



Pull out by hand



let flow out rest of oil



Pulling out the plunger oil will flow out the tool, work above a drain container.

5.3.2 Push out the hydraulic plunger (X16)

To push out the hydraulic Piston (X16) can be by hand or push it on a hard surface.



By hand



hard underground



By hand



ard underground



Once the hydraulic piston (X16) is pushed out the hydraulic body (X12 or X13) always replace the seals in the hydraulic body (X14)

5.3.3 Dismantle the seals (X14)

Once the hydraulic plunger (X16) is dismantled, dismantle also the hydraulic seals inside the hydraulic body (X12 or X13). Use the special tools for dismantling the seals.

RT0033
RT0034
RT0035
RT0046

Use each distance rod for the correct seal, this helps to prevents damaging inside surfaces.



Example of dismantling a seal



Be careful not to damage the inside surfaces

5.3.4 Disassembling the insertion (X20)

To disassemble the insertion (X20) use a wrench 19.



Notice O-ring



Notice the O-ring at the top of the insertion (between insertion and hydraulic body)

5.3.5 Dismount the seals of the insertion (X24)

Once the insertion (X14) is dismantled and if necessary, you can dismount the seals of the insertion

RT0036

RT0037

RT0038

RT0046

Use each distance rod for the correct seal, this helps to prevent damaging inside surfaces

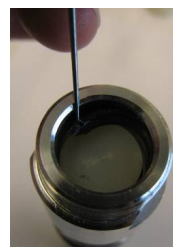

Example of dismantling a seal



It is not necessary to dismantle the hydraulic insertion seals (X24) each time when the insertion (X20) is dismantled

6 ASSEMBLING

Assembling the tool depends on the level the tool is disassembled. This repair manual handles the assembling of the tool from starting point.

This assembling instruction must be follow in the given sequence.



Pictures repair tools can differ from the original repair tools

6.1 Assembling seals hydraulic body (X14)

When ordered the body (X12 or X13) by your subcontractor the seals already placed inside the body.

X12 for EZM1000

X13 for EZM2000

When it is necessary to replace the seals in the body, follow the following steps.



Be aware that you do not damage the seals, work always in a clean environment. Do not use any sharp tool, use special tool RT0044 or a dentist hook with ballpoint

Order of placing the seal set hydraulic body (X14) in the hydraulic body

1. guiding band
2. X - ring 15,54x2,62 70 Sh
3. Stepseal 16 + O - ring 17,17/1,78 Sh 70



Step 1: Placing the guiding band (1)

- Place the special tool **RT0034** in the back of the tool until it blocks



- Place the guiding band (1) and place it into the groove at the front of the body. Use a none sharp tool to assemble the guiding band.



Step 2: Placing the X-ring (2)

- Place the special tool **RT0033** in the back of the tool until it blocks



- Place the X - ring 15,54x2,62 70 Sh (2) and place it into the middle groove of the body



Place X-ring



place with a none sharp tool



X-ring may not be twisted.

Step 3: Placing the stepseal including the O’ring (3)

- Place the special tool **RT0035** in the back of the tool until it blocks



- Place the O - ring 17,17/1,78 Sh 70 (3) in the last groove
- Place the Stepseal 16 (3) and place it the last groove. The stepseal (3) must before fitting in the groove bend like a kidney (without sharp edges) and without sharp tools. Place in the last groove. Push the stepseal in the groove until it fits well.



Bend as a kidney and place



bend out the kidney until it fits in the groove

1.1 Assembling seals hydraulic Piston (X16)

When ordered the assembled hydraulic piston (X15) at Masterfix Products by the seals already are placed on the hydraulic piston (except the guiding band which will be delivered as a none assembled item).

When replacing the seals (X16) on the hydraulic piston, follow the following steps



Be aware that you do not damage the seals, work always in a clean environment. Do not use sharp tools.

Order of placing the seal set on the hydraulic piston (X16)

1. Stepseal 32 + O - ring 22/3 Sh 70
2. X - ring 24,99x3,53 Sh 70
3. guiding band
4. O - ring 12/2,5 VITON
5. Teflon PTFE FOA 32

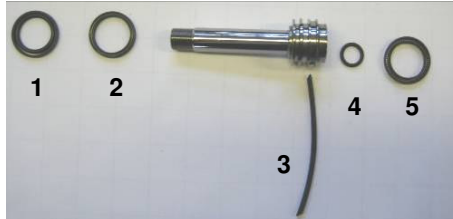

Step 1: Placing the X-ring

- Place the special tool **RT0008** over the shaft of the piston over the groove of the stepseal 32.



- Place the X-ring (2) in the middle outer groove. Push it over the special tool RT0008 with your hands.



X-ring may not be twisted.

Step 2: Placing the O-ring and the stepseal

Place the O - ring 22/3 Sh 70 + stepseal 32 (1) by hand.

- First place O'ring
- Second place Stepseal



Be aware that the Stepseal can damaged. Do not mount it with any tool, only by hand

Step 3: Placing Teflon PTFE FOA 32

Place the Teflon PTFE FOA 32 (5) at the outer back groove



Step 4: Placing the inner O - ring 12/2,5 VITON

Place the O - ring 12/2,5 VITON (4) in the inner groove of the hydraulic piston

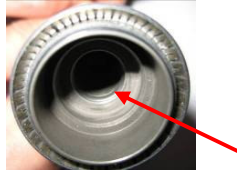

Step 5: placing the guiding band

Place the guiding band (3) in the second groove from behind. Hold the guiding band on place by an O-ring (not specified) or similar.



6.2 Assembling the hydraulic piston (X15) in the Hydraulic Body (X12 OR X13)

When the seals were placed in the Hydraulic body and on the hydraulic piston, the hydraulic piston can be assembled in the hydraulic body.

Step 1: preparing assembling hydraulic piston (X15) in hydraulic body (X12 or X13)

Place the special tool RT0011 on the hydraulic piston to cover the screw thread.



Step 2: greasing the assembling parts

Grease the following parts with silicon grease

1. grease the complete hydraulic piston

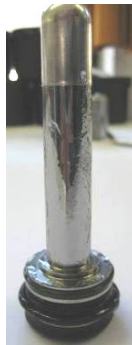

do not use too much grease

2. grease all inside surface and seals of the hydraulic body



Step 3: assembling the hydraulic piston (X15) in the body (X12 or X13)

Assembling the hydraulic piston in the hydraulic body done by pressing equipment (such as a drill press) you can use the special tool **RT0033** to push in the hydraulic piston completely.

- Be sure the special tool RT0011 is placed over the screw thread (you can hold it on place by some grease)
- Place the hydraulic piston in by hand until the first seal of the hydraulic piston hits the hydraulic house
- Screw on the front-sleeve (X11)
- Place special tool RT0033
- Press careful with the pressing equipment, until the hydraulic piston is completely pressed to the front

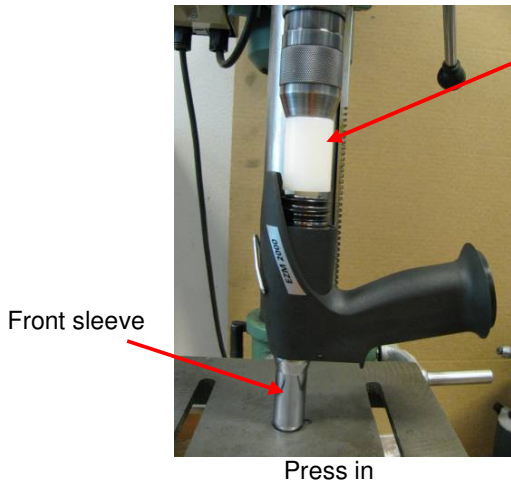

- Unscrew front-sleeve, and take out/off all special tools



Be careful with the first seal which pressed in, that this one does not push off or bends. Also, be careful that the plastic body will not damage.

6.3 Assembling the main valve (X21)

The main valve (X21) can be purchase as a complete part.



Step 1: Grease the valve

- Use the grease and grease all parts (except the nylon ball) from the inside and outside.



- Grease the inside of the body where the valve will be placed



Step 3: placing the valve and valve house

- Place the valve inside the valve house



- place the assembled valve & house in the valve opening of the body by pushing it by hand

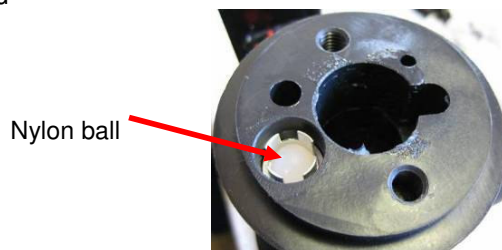

- Place the nylon ball in the top of the valve house

Step 4: placing the bottom valve

- Place the valve bottom in the body and push it by hand until the surface of the body and valve bottom are equal

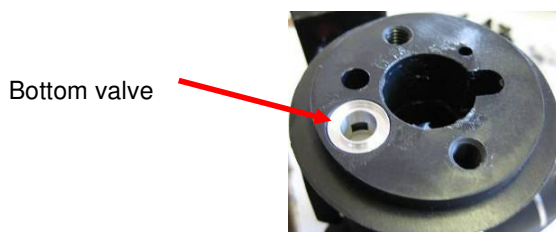

- Place the O-ring
place the O-ring 9/2 Sh 70 in the groove of the valve bottom

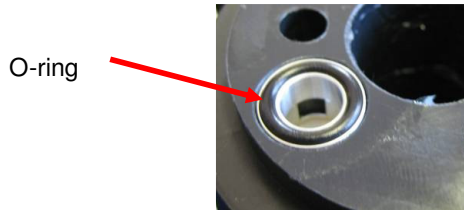

 **Placing the main valve (X21), can also be place after placing the insertion (X20)**

6.4 Assembling seal set insertion hydraulic body (X24)

When purchase the insertion (X20) by your subcontractor the seals already placed in/on the insertion for hydraulic body (X20).

When it is necessary to replace the seals (X24) in the insertion for hydraulic body, follow the following steps

 **Be aware that you do not damage the seals, work always in a clean environment. Do not use any sharp tool, use special tool RT0044 or a dentist hook with ballpoint**

1. O - ring 15/1,5 Sh 90
2. O - ring 18/2,2 VITON

Order of placing the Seal set Insertion (X24) in the insertion.

3. Glyd Ring + O - ring 17,12/2,62 Sh 70
4. O - ring 14/2 VITON
5. guiding band

Seal (1) and (2) are not delivered with the seal set (X24) but are delivered with the Insertion for hydraulic body (X20).

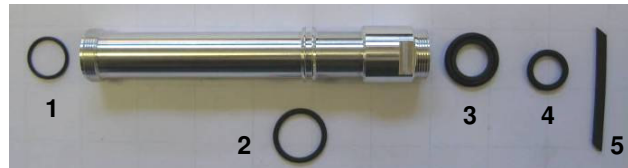

Step 1: place outer O'ring

Place the O - ring 18/2,2 VITON (2) in the outer groove



Step 2: placing the guiding band

- Use the special tool **RT0036** and place it from the top side in the insertion for hydraulic body



- Place the guiding band (5)



Step 3: Placing the inner O'ring

- Use the special tool **RT0037** and place it from the top side in the insertion for hydraulic body



- Place the O - ring 14/2 VITON (4)

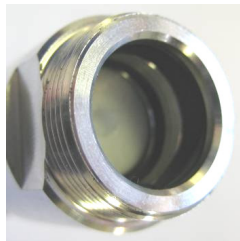

Step 4: placing the Glyd Ring + O - ring

- Use special tool **RT0038** and place it from the top side in the insertion for hydraulic body



- Place the Glyd Ring + O - ring 17,12/2,62 Sh 70 and place it in the last groove first the O-ring then the Glyd ring. Before placing the Glyd ring bend it like a kidney (without sharp edges) and without sharp tools. Push the Glyd ring in it's place until it fits well



Bend as a kidney and place



bend out the kidney until it fits in the groove

Step 5: place the O-Ring 15/1,5 Sh 90

Place the O-ring 15/1,5 Sh 90 on the top of the insertion of the hydraulic body and put some grease



6.5 Assembling insertion (X20)

When the seals where assembled, the insertion can be screwed in the body.

Use special tool **RT0048** for clamping the body up side down in the tool support.

Step 1: grease the inside of the body

Grease the inside of the body with the silicon grease from the top too the bottom.

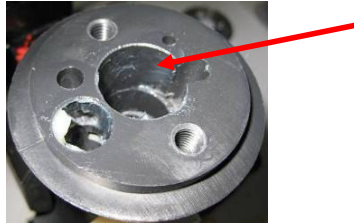

Step 2: assemble the insertion in the body

Place the insertion in the body and screw it in as far it can with hand.



Step 3: tighten the insertion

Tighten the insertion firmly with a wrench 19.



6.6 Assembling complete retraction system (X17)

The complete retraction system (X17) built up out of separate parts. These can be purchase by your subcontractor.

Step 1: preparing nut of body

1. Place the O - ring 38/2 Sh 70 on the nut
the O-ring can also be delivered as separate part (X17a)



2. Grease all inside surfaces of the nut



O-ring (X17a) must be replaced every time the nut is unscrewed from the body

Step 2: screwing the nut in the body

1. screw in with hand for a few thread turnings



2. use special tool **RT0017** to screw in the nut completely in the body and tighten the nut firmly



Step 3: preparing and assembling the T-part piston (X18)

The T-part piston is a pre-assembled part (X18) which can be purchased by your subcontractor. Place the tool vertical in your tool support and fix it well.

1. grease the T-part piston



2. place the T-part piston at the back side of the nut of body



3. Grease the back side of the nut of body



Step 4: completing the retraction system

1. Place the plastic wheel



2. assembling the separate parts

- assembling the steel ball 8mm. place this ball in the shallow breach of the plastic wheel
- Assembling the spring and the steel ball 5mm in the hole of the plastic wheel and hold it on it's place by using some grease

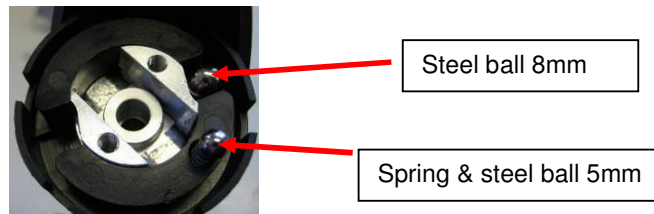

- Assembling the small pin, first place the spring inside the small pin
Place the small pin and spring in the deepest breach of the plastic wheel with the rounding of the small pin to the outside.

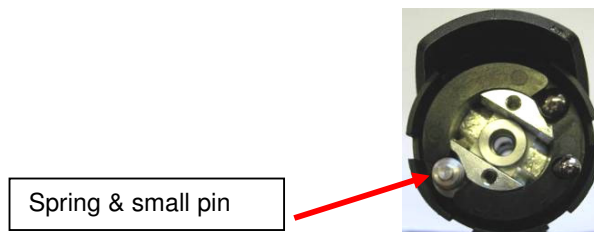

Step 5: screwing on the hood

- Turn the plastic wheel in one of the two outer directions. Prefer the closing position; this is the position where the steel ball 8mm is pushed to the outer side.
- Notice the position of the screw holes and the hole where the steel ball 5mm will fall in.

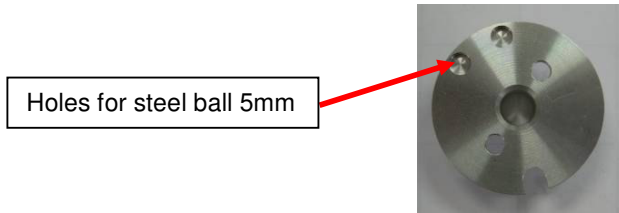

- Place the hood vertical towards the plastic wheel and hold this with your hand on its place. Screw in the cap screws, but don't screw them firmly. When the screws are placed turn the plastic wheel into the begin position and then tighten the screws firmly.



Screw in the screws, but not tighten

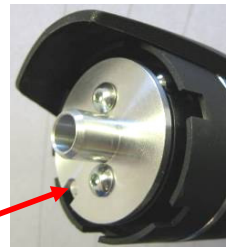

Turn until small pin is visible and tighten the cap screws



Don't move the hood, because then the steel ball 5mm can jump away

6.7 Assembling the air supply ring (X22) or (X23)

The air supply is different for the EZM1000 & EZM2000 both versions will be explained separately.

6.7.1 Air supply ring EZM1000 (X22)

When purchase air supply ring (X22) by your subcontractor, the O-rings and brand sticker already assembled.



When the seals are out of the air supply ring, you can assemble it again in the following way



Be aware that you don't damage the seals, work always in a clean environment

Order of placing the seals in the air supply ring

1. O - ring 63/2 Sh 70
2. O - ring 60/2 Sh 70
3. air supply ring (including brand sticker)

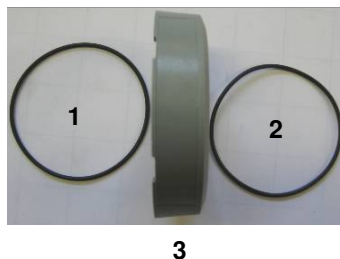

Step 1: assembling the air supply ring (X22) on the body bottom part 1 (X42)

Place the air supply ring (X22) over the body bottom part 1 (X42)



Step 2: place the O'ring

Place the O - ring 4/1,5 Sh 70 (delivered by the pneumatic tube X34) and hold with some grease on it's place

You can order a seal set (X36) separately.

4. O - ring 7/2 Sh 70
5. O - ring 4/1,5 Sh 70



Step 3: assembling the pneumatic tube (X34)

To assemble the pneumatic tube you need the following parts

6. assembled supply ring (X22) and body bottom part 1 (X42)
7. Body bottom part 2 (X43)
8. pneumatic tube (part of X34)

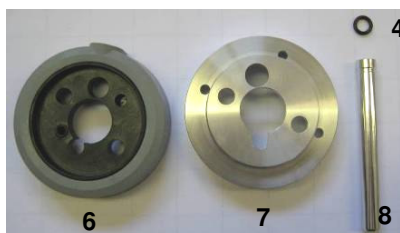

- Place the assembled supply ring (6) on the body bottom part 2 (7) according bellows orientation. Position A and Position B. Grease a little bit the surface of the body bottom part 2 (7)

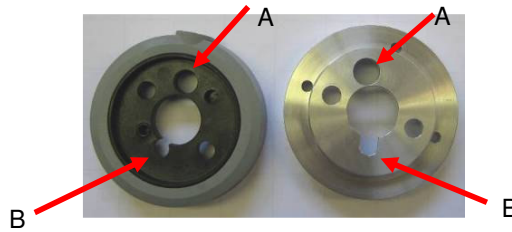

- Put the pneumatic tube (8) in the body bottom part (X42) place in hole A from the top of the body bottom part 1 (X42).



- Place the O - ring 7/2 Sh 70 (4) on the top of the pneumatic tube (8) and hold it on place with some grease.

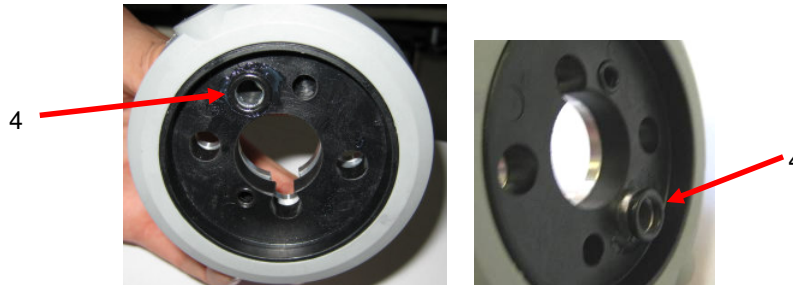

Step 4: place the assembled air supply ring on the body



Be careful that you place the air supply ring straightaway in the correct position. Do not turn the air supply ring once placed on the body. Otherwise, the O-ring will displace.

Place the air supply ring orientated by position A and position B

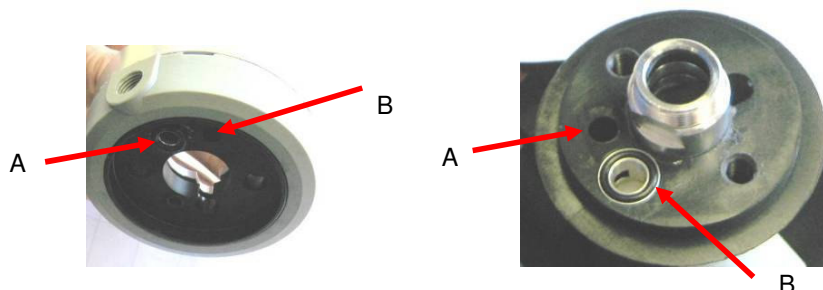

Step 5: fixation of the air supply ring

Fix the air supply ring with the two cap screws M8 (X41) and tighten them firmly

**6.7.2 Air supply ring EZM2000 (X23)**

When purchase the air supply ring (X23) by your subcontractor the O-rings and brand sticker are already assembled

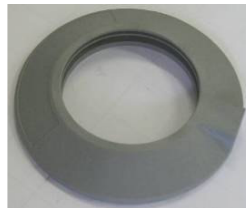

When the seal are out of the air supply ring you can mount it again in the following way.



Be aware that you don't damage the seals, work always in a clean environment

Order of placing the seals in the air supply ring:

1. O - ring 63/2 Sh 70
2. O - ring 60/2 Sh 70
3. air supply ring (including brand sticker) (X23)

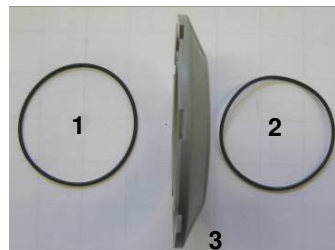
**Step 1: assembling the air supply ring (X23) on the body bottom (X44)**

Place the air supply ring (X23) over the body bottom (X44)



X23

X44

Step 2: place the O-ring

You can purchase a seal set (X36) separately.

4. O - ring 7/2 Sh 70
5. O - ring 4/1,5 Sh 70

Place the O-ring 4/1,5 Sh 70 (delivered by the pneumatic tube X35) in the cut-out (A) of the body bottom (X44) and use some grease to hold the O-ring on it's place, grease also a little bit the surfaces.

**Step 3: assembling the pneumatic tube (X35)**

To assemble the pneumatic tube you need the following parts

6. assembled supply ring (X23) and body bottom (X44)
 7. pneumatic tube (part of X35)
- Put the pneumatic tube (7) in the body bottom (X44) placed in hole A from the top of the body bottom (X44).

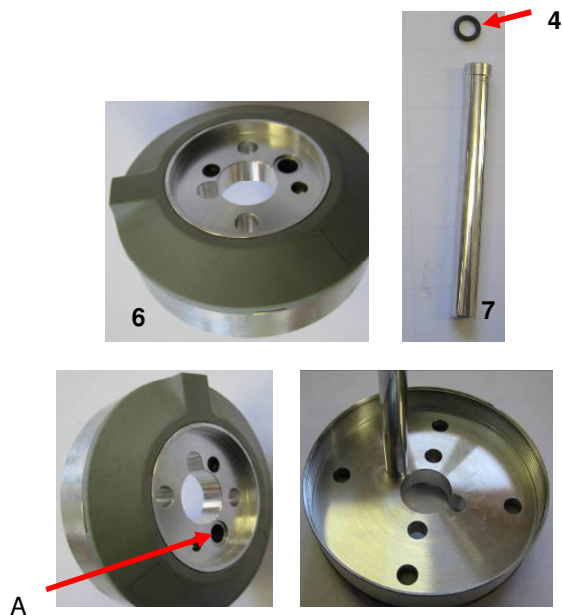

- Place the O - ring 7/2 Sh 70 (4) on the top of the pneumatic tube (7) and hold it on place with some grease.

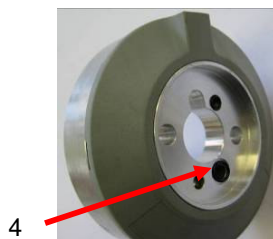

Step 4: place the assembled air supply ring on the body

 Be careful that you place the air supply ring straightaway in the correct position. Do not turn the air supply ring once placed on the body. Otherwise, the O-ring will displace.

Place the air supply ring orientated by position A, B & C

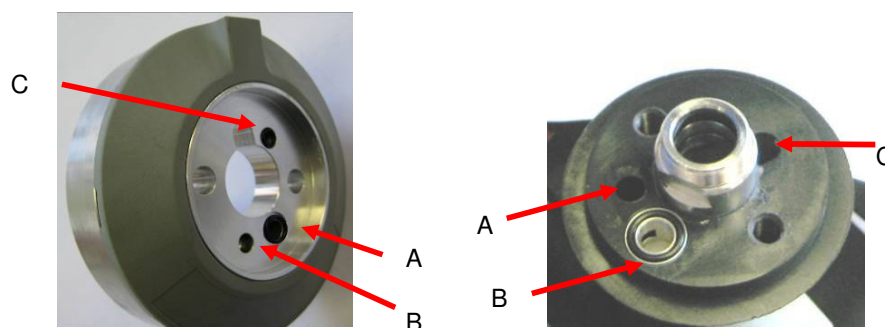

Step 5: fixation of the air supply ring

Fix the air supply ring with the two cap screws M8 (X41) and tighten them firmly



6.7.3 Assemble the assembly nut for both versions (X45)

Finally, the assembly nut (X45) must be placed for a secure fixation of the insertion (X20)

- Use special tool **RT0012**

Screw the assembly nut (X45) by hand on the insertion (X20) and use the special tool **RT0012** to tighten the assembly firmly

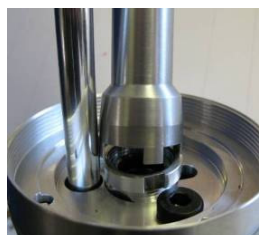

Place the special tool

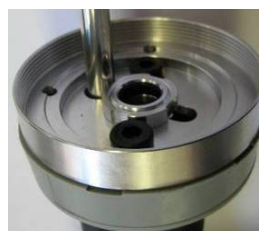

fix it firmly

6.8 Assembling complete trigger (X39)

The complete trigger (X39) can be purchased as pre-assembled and separate parts.

1. pre assembled valve (X39)
2. trigger piston
3. trigger pin
4. trigger

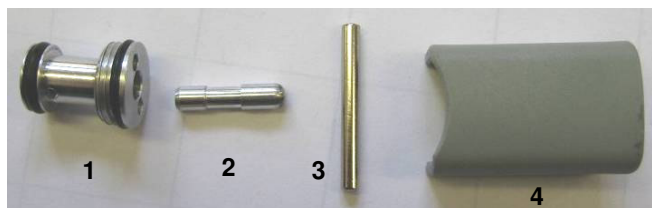

For assembling of the valve, you need the special tool **RT0020**

Step 1: Grease the parts

- grease the pre assembled valve (1) with a silicon grease including the trigger pin (3)

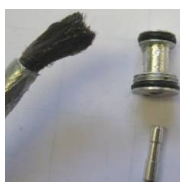

- grease the inside of the valve house in the body



Step 2: screw on the pre-assembled valve (1)

Use special tool **RT0020** and screw in the valve until the top surface of the valve and the surface of the body are on the same level.



Screw in with special tool

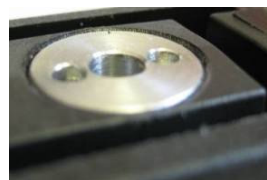

Surface must be equal

Step 3: place the trigger piston

Place the trigger piston (2) with the flat surface inside the pre-assembled valve (1). Push the trigger piston much as possible inside the valve. Grease the trigger piston (2) before you assemble.



Place the trigger piston with the round head at the outside.

Step 4: place the trigger

- place the trigger (4) inside the groove



- Place the trigger pin (3) from the left or right side of the body and push it completely in the body. The trigger pin must place in the center. This can be done by special tool RT0044



6.9 Assembling the air connector tube including the pressure relief valve (X37) or (X38)

The air connector tube and the pressure relief valve will be delivered as a complete set, but with separate parts (X37) & (X38). These are different versions for the EZM1000 & EZM2000.

For assembling the pre-assembled pressure, relief valve (3) uses the special tool **RT0044** or a similar dowel pin etc.

1. pre assembled hose
2. protective ring
3. pre assembled pressure relief valve (differs per version)



Version EZM1000 (X37)



Version EZM2000 (X38)

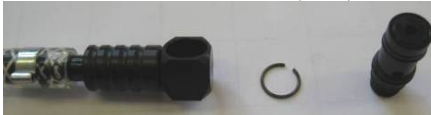

Difference between the two versions

Step 1: assembling the pre assembled pressure relief valve on the air supply ring

- Screw in the pre assembled pressure relief valve with your hand much as possible



- Tighten it firmly with the special tool **RT0044**, by putting it in the open hole of the pre assembled pressure relief valve



Step 3: greasing the parts

Grease the pre assembled pressure relief valve (3) with a silicon grease



Step 4: assembling the pre assembled hose (1)

Slide the pre-assembled hose (1) carefully over the pre assembled pressure relief valve (3)



Be careful not to damage the O-rings.

Step 5: place the protective ring (2)

Place the protective ring in the groove of the pre assembled pressure relief valve (3)



6.10 Assembling the scraper ring and nut (X08)

The scraper ring and nut (X08) will deliver as a set, but are separate parts.

Step 1: placing the nut

Screw the nut on the hydraulic piston until almost the end of the screw thread. Position it that the cylindrical part is pointing to the front of the tool.



Step 2: place the scraper ring

Place the scraper ring over the cylindrical part of the nut. This can also be done when before screwing on the clamping sleeve.

6.11 Assembling the conduit,

The conduit is a pre-assembled part and differs for the EZM1000 & EZM2000.

For assembling the conduit use special tool **RT0041**

X09 for EZM1000

X10 for EZM2000

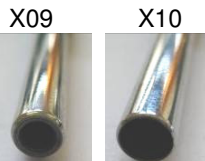

Step 1: Greasing the conduit

Grease the conduit with silicon grease

Step 2: placing the conduit in the tool

- Place the conduit in the front of the hydraulic piston for half of the length.



- Put the special tool **RT0041** in the back of the tool and push the conduit towards the special tool. Push the conduit and the special careful to the back until the conduit is inside the hydraulic piston.



Place the conduit careful to prevent damaging of seals. Use the special tool RT0041 for centering the conduit.

6.12 Place jaw pusher / clamping sleeve (X06 or x07) & the jaws (X05)

The jaws (2pcs) (X05) and the jaw pusher incl. clamping sleeve (X06) can be ordered as a separate sets.

Step 1: placing of the jaws

Place the jaws (X05) in the clamping sleeve (part of X06/X07)



Step 2: lubricate the inside of the clamping sleeve and the jaws

Lubricate the inside of the clamping sleeve and the jaws with some hydraulic oil.



Do not use grease, but use hydraulic oil or similar. Do not lubricate too much!

Step 3: place the Jaw Pusher

Place the jaw pusher in the clamping sleeve or directly in the hydraulic piston.



Step 4: screw on the clamping sleeve on the hydraulic piston

Screw the clamping sleeve on the hydraulic piston until the nut



 Do not tighten the clamping sleeve

6.13 Before the hydraulic oil is filled, test if the tool is assembled well

Before you fill the tool with oil you must check if the tool has any air leakage.

Step 1: connect the tool to the air supply

- Place the tool in tool support **RT0048** up side down and fix it well.
- Be sure that the switch is set to OFF (position the switch towards the hose)

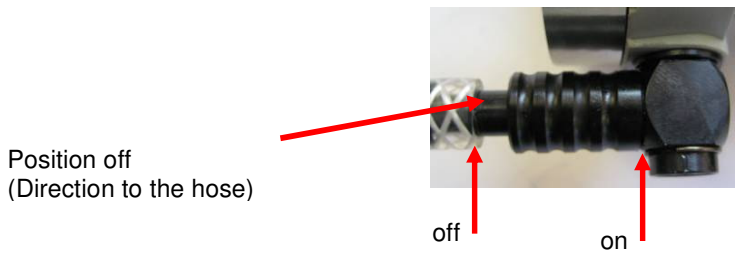

- Connect the tool to the air supply

 Be sure that the tool has been assembled as mentioned in the steps before.

Step 2: test procedure

- Cover with your finger the exhaust of the pneumatic tube



- Activate the tool by pushing the switch to the ON position
- Listen if you hear any leakage.
(If there is an air leakage check where it is and assemble the part again)
- Activate the trigger several times and hold it in each position and listen if you hear any leakage.

 If no leakage is notice proceed with the following steps

Step 3: Shut off and disconnect the tool

Shut off and disconnect the tool at the correct way.

- Do not operate the trigger anymore
- Shut off the air supply to the tool by pushing the ON/OFF switch to the OFF position
- Disconnect the air supply from the hose



Be sure that the hydraulic piston is pushed completely to the front of the tool. If not, pull the hydraulic piston completely out with your hands.

6.14 Filling the tool with oil



When hydraulic parts are not disassembled during service/maintenance these oil-filling steps are not necessary!

Use the special tool **RT0048** to clamp the tool in vertical position.

- Fill the tool with hydraulic oil **RT0049**

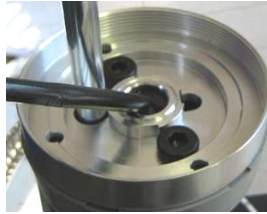

- Fill the tool until the top of the insertion (X20)

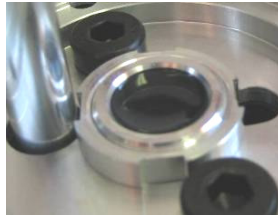

- Leave this position for a several minutes (2 or 3) too let out the air bubbles.

6.15 Assembling the pneumatic plunger (part 1) (X25 or X26)

The pneumatic plunger (part 1) (X25 & X26) is a pre-assembled part including the caps screw and O-ring (X31). Pneumatic plunger (part 1) differs per version:

X25 for EZM1000
X26 for EZM2000

Use the special tools **RT0022** or **RT0026** and **RT0039** including a standard **combination grip**

- Special tool RT0022/RT0026 is different for both tools

The cap screw with O-ring (X31) can also be delivering as a separate set. Cap screw and O-ring must be replaced every time when the cap screw is unscrewed.

1. pneumatic plunger (part 1)
2. cap screw M4x8
3. O-ring 4/1,5

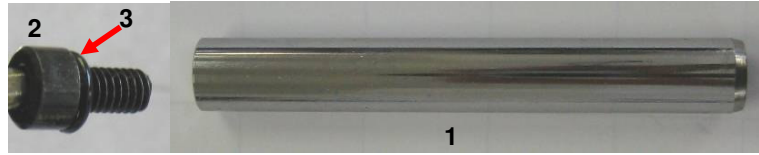

Cap screw and O-ring must replace every time when the cap screw is unscrewed.

Step 1: assembling the pneumatic plunger (part 1)

Place the pneumatic plunger (part 1) (1) carefully in the hydraulic insertion. Be sure the cap screw (2) is not screw in the pneumatic plunger (part 1) (1).

Be Careful when pushing in the pneumatic plunger (part 1) (1), for preventing the damaging of the seals!

Push it so far that the distance between the hydraulic plunger (X25/X26) is positioned approximate 5mm under the pneumatic tube (X34/X35)

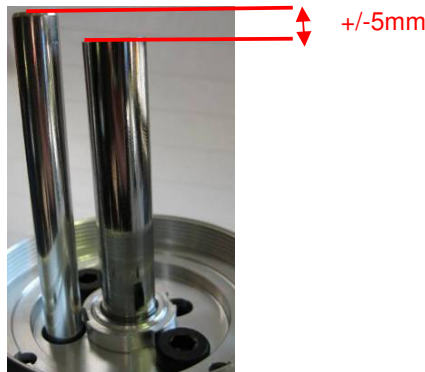

Be sure the cap screw is not screw in the pneumatic plunger (part 1)



Do not push the pneumatic plunger (part 1) too far in the insertion. Once passed the seals, stop pushing (+/-5mm). Otherwise, the oil will spout out.

Step 2: place the special tool RT0022 or RT0026 for filling the tool with oil correctly

To position and fill the tool correctly with oil, place the special tool **RT0022 or RT0026** by screwing it on by hand until it is screw on completely.



Step 3: place the oil filling syringes

Use special tool **RT0029**

- Use the O-ring 4/1.5 of the cap screw, and place over the screw thread of the syringe.
- Place a filled syringe "RT0029 + RT0049" by screwing it in the insertion.

Step 4: complete the oil filling and releasing the air bubbles

- Push in the syringe completely, do this once



- Leave the syringe in the syringe



Be sure the syringe is screwed on well and that no leakage can occur (O-ring 4/1.5 on the syringe must be placed)

Step 5: connect the tool to the air supply

- Be sure that the switch is set to OFF (position the switch towards the hose)

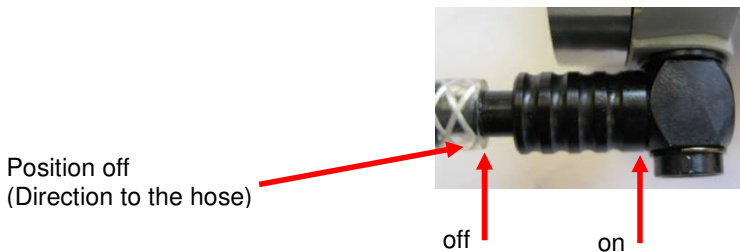

- Connect the tool to the air supply
- Activate the tool by pushing the switch to the ON position



DON'T ACTIVATE THE TRIGGER. USE EYE PROTECTION GLASSES

Step 6: shut off from the air supply

Shut off the air supply to the tool by pushing the ON/OFF switch to the OFF position

Step 7: Repeat step 4 to 6

Repeat step 4 to 6 two or three times in the following order. Until no air bubbles escape in the syringe.

- **Disconnect tool from air supply**
- **Press the syringe, when the tool is disconnect from air supply**
- **Connect to the air supply**

Step 8: unscrew the special tools

- Unscrew the syringe
- Unscrew the special tool **RT0022** or **RT0026** from the tool

Step 9: place the cap screw with O-ring (X31)

- Place the special tool **RT0039** on the hydraulic plunger (X25 or X26) and hold the special tool **RT0039** on it's place and grip the pneumatic plunger (part 1) (X25 or X26) with a standard combination grip or similar



- Place the cap screw with O-ring (X31) and fix it firmly with hexagonal key for M4

**6.16 Assembling the pneumatic plunger (part 2) (X27 or X28)**

The pneumatic plunger (part 2) (X27 or X28) is a pre-assembled part and differs per version.

When ordered the seal sets (part 2) (X29 or X30) for the pneumatic plunger follow the following steps to assemble the seals on the pneumatic plunger

1. pneumatic plunger board PP
2. seal 70x60x4,5 (EZM1000) / Seal 90x80x4,25 (EZM2000)
3. Seal 14

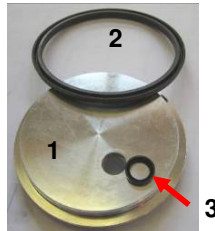
**EZM1000:**

X27 pneumatic plunger (part2)
X29 Seal set pneumatic plunger (part2)

EZM2000:

X28 pneumatic plunger (part2)
X30 Seal set pneumatic plunger (part2)

Step 1: assemble the inner Seal 14

Assemble the inner seal 14 (3) in the pneumatic plunger (part 2) (1). Orient the seal 14 (3) with the flaps to the bottom side.

Place the seal 14 (3) inside this direction



Step 2: assembling seal 70x60x4,5 (EZM1000) or 90x80x4,25 (EZM2000) (2)

Assemble the seal 70x60x4,5 (for EZM1000) or 90x80x4,25 (for EZM2000) (2) on the pneumatic plunger (part 2) board PP. from the bottom side



Be aware that you don't damage the seals, work always in a clean environment

Step 3: grease the pneumatic plunger (part 1)

Grease the pneumatic plunger (part 1) (X25 or X26) including the pneumatic tube (X34 or X35)



Step 4: assemble the pre-assembled pneumatic plunger (part 2) (X27 or X28)

- Place the pneumatic plunger (part 2) (X27 or X28) with cylindrical protrusion inside the pneumatic plunger (part 1) (X25 or X26)
- Push the pneumatic plunger (part 2) halfway the pneumatic tube (X34 or X35)



6.17 Assembling the pneumatic cylinder (X32 or X33)

The pneumatic cylinder (X32 or X33) differs per version

X32 for EZM1000

X33 for EZM2000

To assemble the pneumatic cylinder use special tool **RT0047**

Step 1: greasing the inside of the pneumatic cylinder

Grease the inside of the pneumatic cylinder with silicon grease

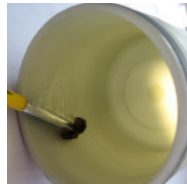

Step 2: assemble the pneumatic cylinder (X32 or X33) on the tool

- Screw on the pneumatic cylinder (X32 or X33) on the body bottom (X43 or X44) by hand
- Tighten the pneumatic cylinder with the special tool **RT0047** and fix it well



When assembling the pneumatic cylinder after service, the pneumatic cylinder cover (X46 or X47) is already placed and glued on this pneumatic cylinder. Use the special tool, the same way but over the pneumatic cylinder cover.

6.18 Fixation of the clamping sleeve (X06 or X07)

For adjusting and securing the clamping sleeve, you need a standard wrench 15 & 17. To measure the correct distance use a Vernier calliper gauge.

Step 1: connect tool to air supply

Before measuring the distance connect the tool to the air supply and operate the tool one time by the trigger.



Keep the tool on the air supply

Step 2: adjust the clamping sleeve

Measure the correct distance for a proper function of the tool.

The correct distance is between the 19,7mm and 20mm from the front of the body (X12 or X13) and the back of the nut (X08), with the air pressure on the tool.



Step 3: tighten the clamping sleeve

Tighten the clamping sleeve (X06 or X07) by using a wrench 15 for the clamping sleeve (X06 or X07) and a wrench 17 for the nut (X08). Tighten both firmly but be sure that the distance does not change.



The distance must be between 19,7mm and 20mm after tightening the clamping sleeve

Step 4: disconnect the tool from the air supply

- Disconnect the tool from the air supply by operating the switch to the OFF position
- Disconnect the air supply from the hose

6.19 Assembling the front sleeve (X11)

The front sleeve part (X11) contains the front sleeve and an O-ring (X11a)

The O-ring (X11a) can also be ordered as a separate part.

1. front sleeve
2. O-ring 25/1,5

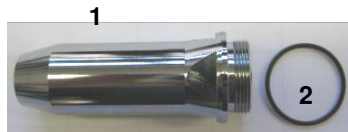

Step 1: place the O-ring (2) (X11a)

Place the O-ring (2) (X11a) over the screw thread in the groove of the front sleeve (1)

**Step 2: screw the front sleeve on the tool**

For assembling the front sleeve (X11) on the tool use a standard wrench 23 and tighten the front sleeve firmly



Be careful not to damage the O-ring (11a) and the trigger (X39)

Step 3: test the adjustment of the clamping sleeve

- Mount the mandrel collector (X19) and turn it to its lock position
- Connect the tool to the air supply
- Do not activate the trigger



By a correct adjustment, you must hear the air suction when the front sleeve (X11) is mounting on the tool

- After the check disconnect the tool from the air-supply

6.20 Placing the balancer (X40)

The balancer can be placed by hand to bend the ends out, fit it in the holes at the top of the body and pushes the balancer ends to each other, as much as possible

**6.21 Placing the pneumatic cylinder cover (X46 or X47)**

The pneumatic cylinder cover (X46 or X47) differs per version.

The pneumatic cylinder cover only needs to be fit on the pneumatic cylinder (X32 or X33) when it came loose. By service on the tool mostly the pneumatic cylinder cover (X46 or X47) remains on the pneumatic cylinder (X32 or X33).

Use Pattex PL600 / powerfix “**RT0053**” or similar for assembling and gluing both parts

Step 1: add the glue

Add the Pattex PL600 / powerfix “**RT0053**” or similar inside the pneumatic cylinder cover (X46 or X47). Add the glue just under the enlarged diameter.



Transition between larger and smaller diameter

Step 2: push the pneumatic cylinder cover over the cylinder

When adding the glue, clamp the tool in the best way you can, and push the pneumatic cylinder cover (X46 or X47) over the pneumatic cylinder (X32 or X33).

- Notice that the serration line of the cover is equal with the body



Serration line body

Serration line cover

- Place it until the top of the cover is equal with the air supply ring (X22 or X23)



Place until top of the cover

7 TECHNICAL DATA

	EZM1000	EZM2000
Weight	1.25kg	1.65kg
Air Pressure	5-7bar	5-7bar
Pull force (6 bar)	7.3kN	12.5kN
Air consumption (per stroke)	1.5l	2.0l
Stroke	17mm	21mm
Capacity (standard blind rivet)	Ø3.0-Ø4.8mm (stainless steel)	Ø4.8-Ø6.4mm (stainless steel)

8 TROUBLESHOOTING

When none of the probable causes has a solution, the tool must be repaired.

Problem	Probable cause	Solution
Tool does not work	Tool has not been connected to the air connection The air supply closing valve is still closed There is insufficient air pressure	Connect the tool to the air connection Open the air supply closing valve Use the correct air pressure 5-7bar
Air is coming out of the safety valve	The air pressure is too high	Use the correct air pressure 5-7bar
It seems air escape from the exhaust continuous	Damaged air supply hose	Replace X37 or X38
The re is no insufficient extraction	The extraction has not been turned on There is insufficient air pressure The mandrel collector is full The tool is blocked by rest mandrels Rubber part collector is clogged	Check the position of the mandrel Collector Use the correct air pressure 5-7 bar Empty the mandrel collector Remove the rest mandrel Free the holes from any obstruction
The trigger does not work	There is insufficient air pressure	Use the correct air pressure 5-7 bar
The blind rivet cannot be placed into the nose piece	The incorrect nose piece has been mounted The tool is blocked by rest mandrels Damaged conduit	Mount the correct nose piece Remove the rest mandrel Replace the conduit X09 or X10 (perhaps it is necessary to replace the complete retraction system X17)
The blind rivet is not set correctly	Contaminated or worn clamping jaws There is insufficient air pressure The capacity of the tool has been exceeded	Clear or replace the clamping jaws Use the correct air pressure Use the correct tool
The rest mandrel does not release from the nose piece	The incorrect nose piece has been mounted The tool is blocked by rest mandrels Damaged conduit	Mount the correct nose piece Remove the rest mandrel Replace the conduit X09 or X10 (perhaps it is necessary to replace the complete retraction system X17)
During setting the rivet mandrel does not break	There is insufficient air pressure The capacity of the tool has been exceeded	Use the correct air pressure Use the correct tool
The rest mandrel is not extracted into the mandrel collector	The incorrect nose piece has been mounted The tool is blocked by rest mandrels The mandrel collector is full Damaged conduit	Mount the correct nose piece Remove the rest mandrel Empty the mandrel collector Replace the conduit X09 or X10 (perhaps it is necessary to replace the complete retraction system X17)
Air suction does not work	Clamping sleeve is not positioned good	Adjust the clamping sleeve at distance of 19,7-20mm and fix it firmly
The air supply unit cannot be turned 360°	The tool is still under air pressure	Close the air supply closing valve and depressurize the tool by turning on the extraction or by operating the trigger
The tool does not perform well consistently		Contact a service centre



Any other failure or problem must be investigated per individual case.

Appendix A: cross section EZM1000

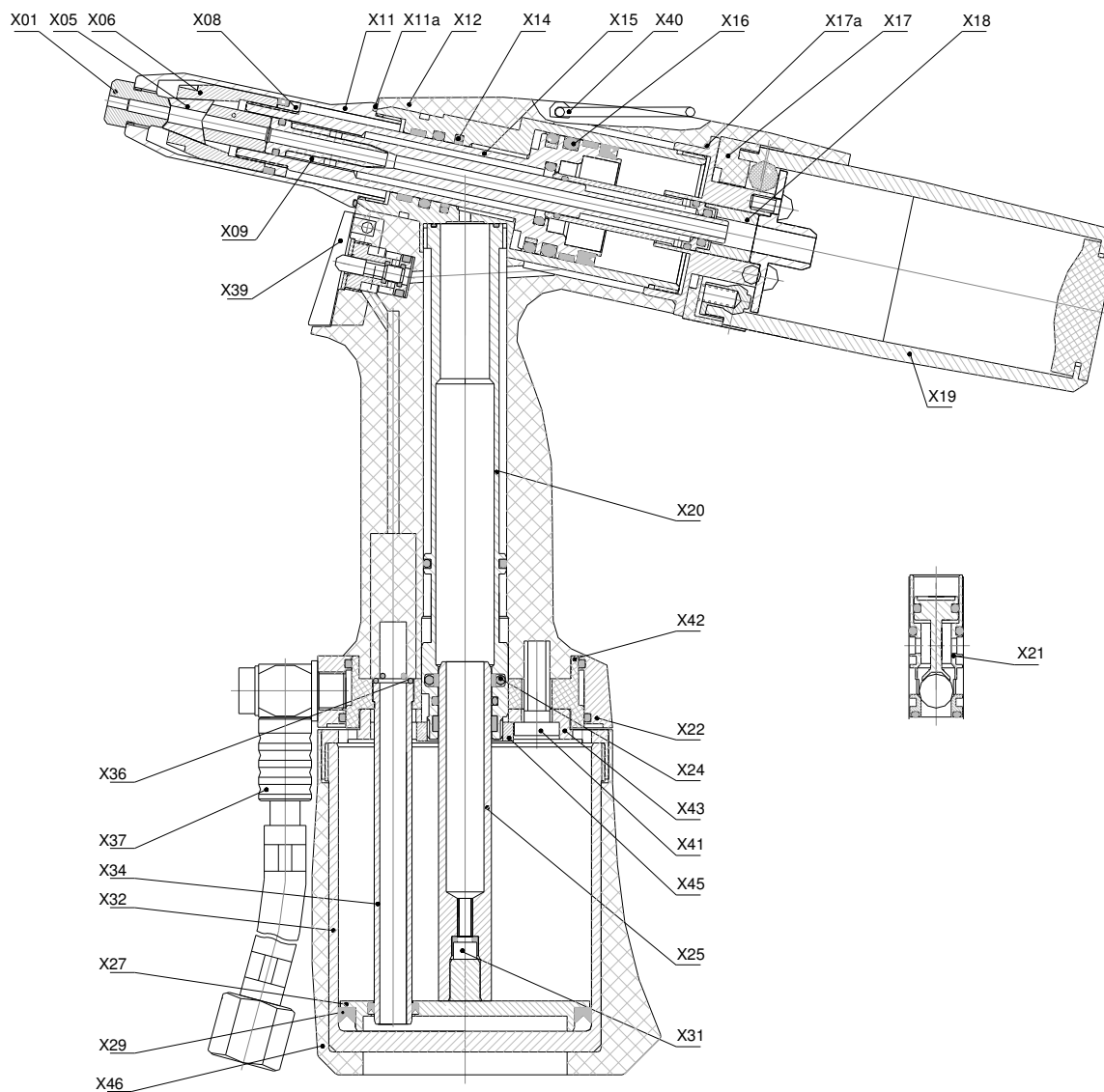

Pos	Description	article nr.
X01	Set of nose pieces 3.0/5.0	900A00226
X05	Set of jaws (2pcs)	900A00224
X06	Set of clampingsleeve and jaw pusher	900A00229
X08	Set of nut and scraper ring	900A00231
X09	Complete tube (piston, conduit and O-ring)	900A00232
X11	Complete Frontsleeve	900A00205
X11A	O-ring for frontsleeve	900S00107
X12	Hydraulic body incl. seal set	900A00206
X14	Seal set hydraulic body	900A00234
X15	Hydraulic piston incl. seal set	900A00225
X16	Seal set hydraulic piston	900A00235
X17	Complete retraction system incl. rear nut hydr. Body	900A00236
X17A	O-ring for rear nut hydraulic body	900S00117
X18	Piston	900A00237
X19	Mandrel container	900A00210
X20	Insertion for hydraulic body incl. seal set	900A00211
X21	Valve	900A00212
X22	Air supply ring	900A00213
X24	Seal set Insertion	900A00238
X25	Pneumatic plunger (part 1)	900A00215
X27	Pneumatic plunger (part 2) incl. seal set	900A00217
X29	Seal set Pneumatic plunger (part2)	900A00239
X31	Cap screw set	900A00247
X32	Pneumatic Cylinder	900A00219
X34	Pneumatic tube incl. seal set	900A00241
X36	Set of seals for pneumatic tube	900A00243
X37	Pressure relieve valve including tube and air connector	900A00221
X39	Complete trigger	900A00223
X40	Balancer	900P01117
X41	Set of 2 assembly screws	900S00129
X42	Body bottom (part 1)	900P01133
X43	Body bottom (part 2)	900A01134
X45	Assembly nut	900A01166
X46	Pneumatic Cylinder Cover	900A01167

Appendix B: cross section EZM2000

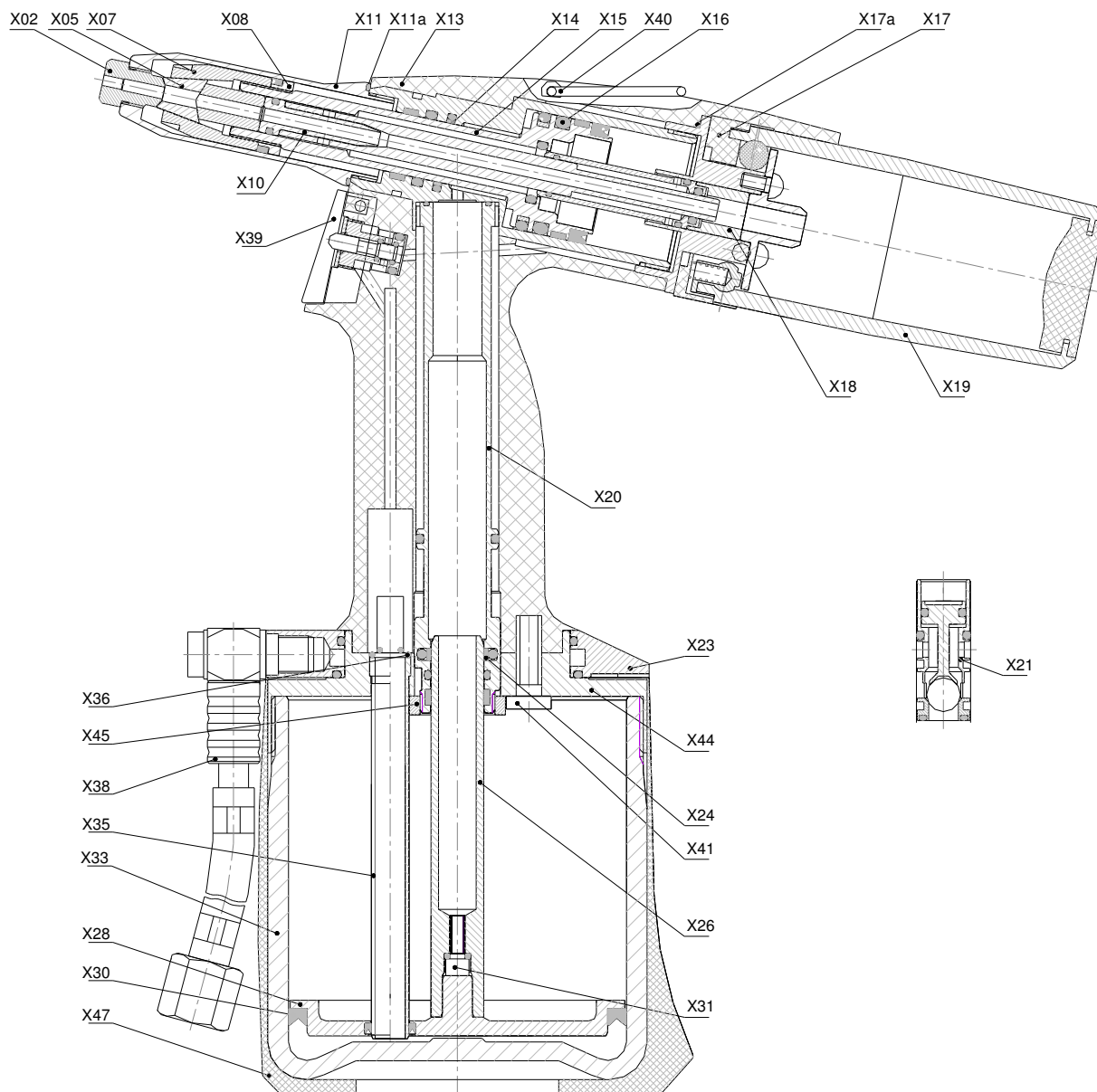

Pos	Description	article nr.
X02	Set of nose pieces 4.0/6.4	900A00227
X05	Set of jaws (2pcs)	900A00224
X07	Set of clampingsleeve and jaw pusher	900A00230
X08	Set of nut and scraper ring	900A00231
X10	Complete tube (piston, conduit and O-ring)	900A00233
X11	Complete Frontsleeve	900A00205
X11A	O-ring for frontsleeve	900S00107
X13	Hydraulic body incl. seal set	900A00207
X14	Seal set hydraulic body	900A00234
X15	Hydraulic piston incl. seal set	900A00225
X16	Seal set hydraulic piston	900A00235
X17	Complete retraction system incl. rear nut hydr. Body	900A00236
X17A	O-ring for rear nut hydraulic body	900S00117
X18	Piston	900A00237
X19	Mandrel container	900A00210
X20	Insertion for hydraulic body incl. seal set	900A00211
X21	Valve	900A00212
X23	Air supply ring	900A00214
X24	Seal set Insertion	900A00238
X26	Pneumatic plunger (part 1)	900A00216
X28	Pneumatic plunger (part 2) incl. seal set	900A00218
X30	Seal set Pneumatic plunger (part2)	900A00240
X31	Cap screw set	900A00247
X33	Pneumatic Cylinder	900A00220
X35	Pneumatic tube incl. seal set	900A00242
X36	Set of seals for pneumatic tube	900A00243
X38	Pressure relieve valve including tube and air connector	900A00222
X39	Complete trigger	900A00223
X40	Balancer	900P01117
X41	Set of 2 assembly screws	900S00129
X44	Body bottom	900P01135
X45	Assembly nut	900A01166
X47	Pneumatic Cylinder Cover	900A01168

The Netherlands (Head Office)

Masterfix Product b.v.
P.O. Box 21
6190 AA Beek
Phone: +31 (0)43 350 84 84
Fax: +31 (0)43 350 84 88

United Kingdom

Masterfix Products UK Ltd.
Units 4a, b & d, Ring Road, Zone 2
Burntwood Business Park, Burntwood
Staffordshire, WS 3JQ
Phone: +44 (0) 1543 686 989
Fax: +44 (0) 1543 675 822

Spain

Black & Decker Ibérica, S.C.A.
Business Unit Masterfix
Ctra. M-300, Km 29, 700
28802 Alcalá de Henares
Madrid
Phone: +34 (0)91 883 5730
Fax: +34 (0)91 880 8720

Poland

Masterfix Poland
ul. Daleka 16
60-124 Poznan
Phone: +48 (0)61 86 66 297/376
Fax : +48 (0)61 86 65 733

Website: www.masterfix.com
E-mail: info@masterfix.com